



**iPad (9th generation) Wi-Fi**

**iPad (9th generation) Cellular**

# Apple Recycler Guide

May 2023

# Contents

3	<a href="#">About This Guide</a>
4	<a href="#">Identification</a>
5	<a href="#">Directive 2012/19/EU Annex VII Components</a>
6	<a href="#">Safety Considerations</a>
8	<a href="#">Recommended Tools</a>
9	<a href="#">Disassembly Instructions</a>
24	<a href="#">Material Categorization of Output Fractions</a>

# About This Guide

Apple Recycler Guides provide guidance for electronics recyclers on how to disassemble products to maximize recovery of resources. The guides provide step-by-step disassembly instructions and information on the material composition to help recyclers direct fractions to the appropriate material recycler.

To conserve important resources, we work to reduce the materials we use and aim to one day source only recycled or renewable materials in our products. A key path to reaching that goal is resource recovery from end-of-life electronics.

Disassembly procedures are intended to be performed only by trained electronics recycling professionals. The recycler is responsible for independently evaluating and ensuring compliance with all applicable environmental, health, and safety laws related to the work. These include but are not limited to laws relating to the management, handling, shipping, and disposal of the outputs of this work as waste and laws in place to ensure the health and safety of all employees who support this work.

For questions or feedback about this guide, email [contactesci@apple.com](mailto:contactesci@apple.com).

**Note:** This guide may show images from other similar models, but the procedures are the same.

# Identification

You can find the model number on the back of the iPad.



*Model numbers:*  
*(Wi-Fi) A2602*  
*(Wi-Fi + Cellular) A2603, A2604, A2605*

# Directive 2012/19/EU Annex VII Components

Directive 2012/19/EU Annex VII requirements apply to the following substances and components.

<b>Substance/Component</b>	<b>Apple Part Name</b>	<b>Removal Instructions</b>
Printed circuit board if the surface is greater than 10 square centimeters	Main logic board, display logic board	Follow steps 1–13
External electric cables	Power adapter	Follow step 1
Battery	Lithium-ion polymer batteries	Follow steps 1–6
Cover glass and liquid crystal display (LCD) cell if the surface is greater than 100 square centimeters	LCD cell	Follow steps 1–5
No further substances or components as listed in Annex VII		

# Safety Considerations

The recycler is responsible for independently evaluating all activities undertaken by its employees to perform or support the work and ensuring compliance with all applicable health and safety laws related to the work. These include but are not limited to laws relating to the health and safety of all employees who perform or support this work. The recycler is also responsible for evaluating the workspace and ensuring that the area in which the work is to be undertaken is designed using ergonomic best practices and meets all ergonomic requirements to ensure the protection of its employees.

## Personal Protective Equipment

Personal protective equipment should be worn during the entire recycling process.



Wear hand protection



Wear protective clothing



Wear eye protection



Wear foot protection

## Battery Safety

This product uses a lithium-ion polymer battery. Before beginning any disassembly work, ensure that a safe working procedure for handling lithium-ion batteries has been established, which could include discharging the batteries so that they can be more safely managed. The following considerations may also be included:

- Remove anything from your person that could conduct energy, such as jewelry and watches, to avoid electric shock to yourself or the logic board.
- To avoid the potential for thermal runaway and the release of potentially noxious fumes, don't puncture, strike, or crush lithium-ion polymer batteries or devices powered by them.
- Don't throw, drop, or bend the battery.
- Don't expose the battery to excessive heat or sunlight.
- Don't use tools that are sharp or conduct electricity.
- Keep your workspace clear of foreign objects and sharp materials.
- Dispose of batteries according to local environmental laws and guidelines.

## Workspace safety guidelines

- Use heat-resistant gloves and safety glasses.
- Keep a sand dispenser within arm's reach (2 feet or 0.6 m) on one side of the workstation, not above the workstation. The dispenser should be a wide-mouthed, quick-pour metal container with a flip-top lid or tray that contains 8–10 cups (1.9–2.4 L) of clean, dry, untreated sand.
- Keep the battery at least 2 feet (0.6 m) from paper and other combustible materials.
- Work in an area with adequate ventilation.

## Handling a thermal runaway

If you notice any of the following signs, a thermal runaway is likely underway, and you should act immediately:

- The lithium-ion polymer battery or a device containing one begins to smoke or emit sparks or soot.
- The battery pouch suddenly and quickly puffs out.
- You hear hissing or popping sounds.

**Don't** use water or an ABC/CO<sub>2</sub> fire extinguisher on a thermal runaway battery or a device containing one. Water and ABC/CO<sub>2</sub> fire extinguishers will not stop the reaction.

**Do** smother the battery or device immediately with plenty of clean, dry sand, dumped all at once. Timing is critical; the faster you pour all the sand, the faster the thermal runaway will stop.

**Do** leave the room for 30 minutes if the thermal runaway causes any irritation.

**Do** wait 30 minutes before touching the battery. Wear heat-resistant gloves and safety glasses to remove the battery from the sand, or use a touchless thermometer to measure the battery temperature. Only touch the battery when the event has finished.

**Do** dispose of the damaged battery or device (including any debris removed from the sand) according to local environmental laws and guidelines.

## Hazard Warnings



Broken glass hazard



Rechargeable battery hazard



Chemical exposure hazard

# Recommended Tools

Miniature pry bar

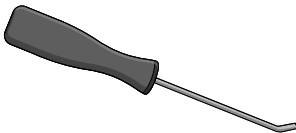

Nail-pulling screwdriver

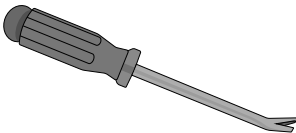

Plastic pry bar

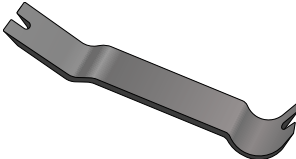

Screwdriver-handle pry bar

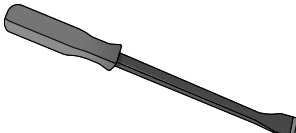

Slip-joint pliers

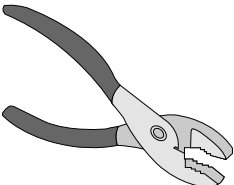



# Disassembly Instructions

## 1. Remove the power adapter and the charge cable.

- » *Ensure that the iPad is turned off.*
- » *Unplug the power adapter. Disconnect both ends of the charge cable.*

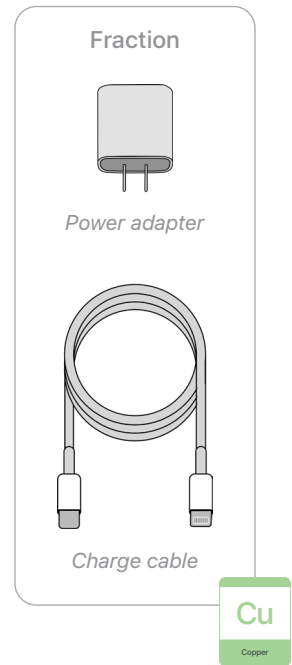

## 2. Remove the display.



Broken glass hazard



Chemical exposure hazard

- » *Hold the iPad at the edge of a counter with the display facing up.*
- » *Insert the tool tip into the Home button/Touch ID sensor. Push the handle down to pry the display from the enclosure.*
- » *Remove the display by hand. Set the enclosure aside.*

### Tools Used

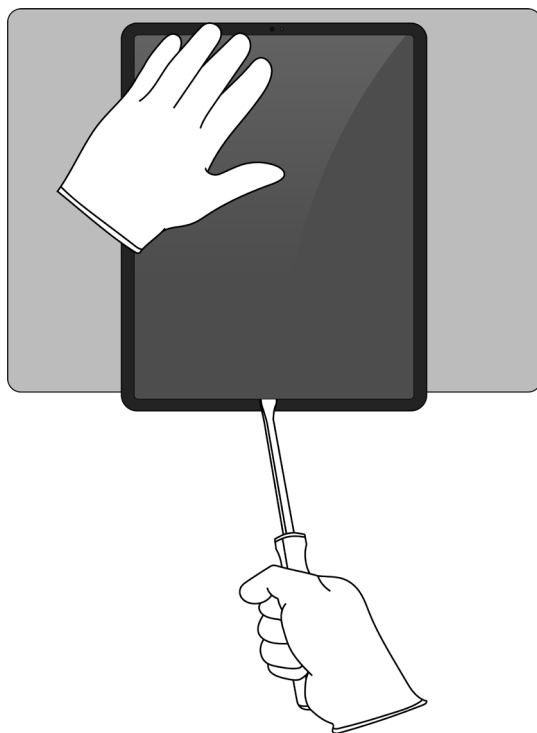
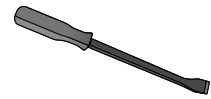

3. With the display facing down, pull off the Home button/Touch ID sensor by hand.

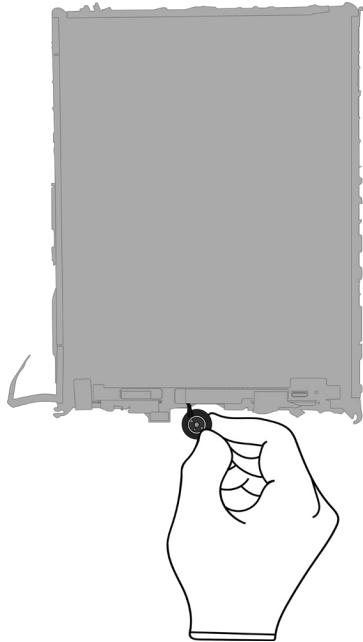

Fraction



Home button/  
Touch ID sensor

Cu  
Copper

4. Pry off the display logic board.

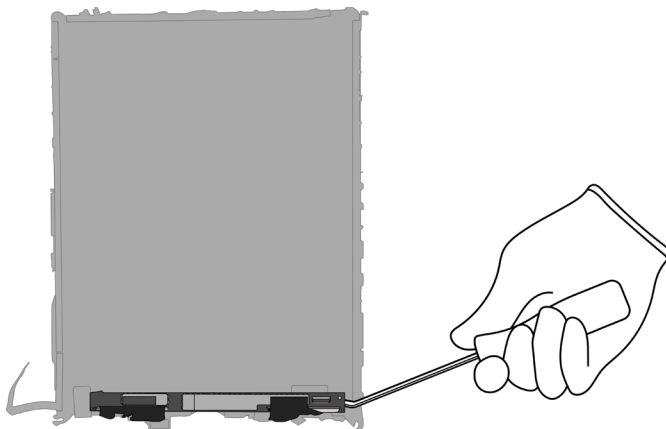

Tools Used



Fraction



Display logic board

PMs  
Precious Metals

**5.** Pull off the ribbon cables by hand.

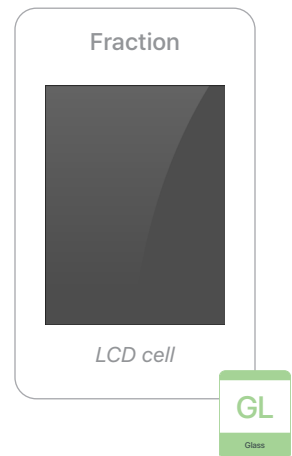
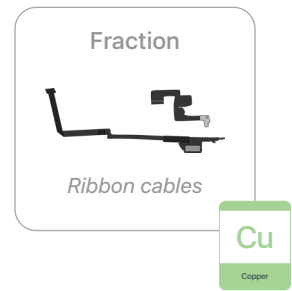
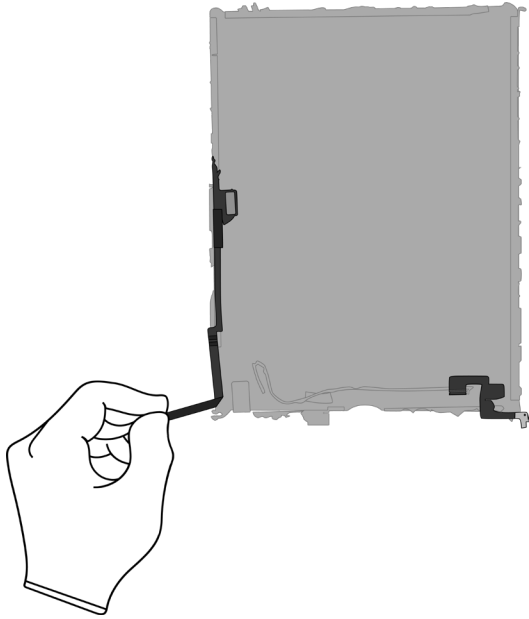

6. From the enclosure, carefully remove both lithium-ion polymer batteries.

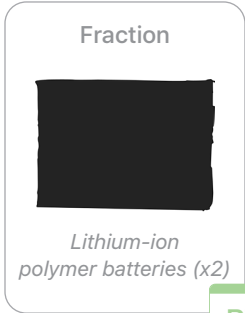
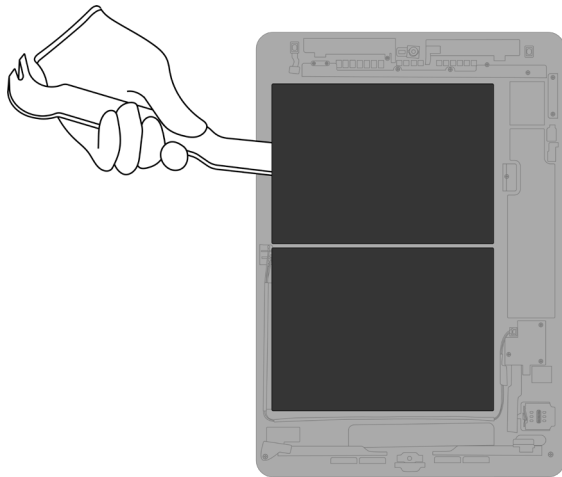
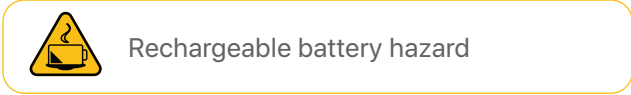

7. Pry off the headphone jack and light sensor.

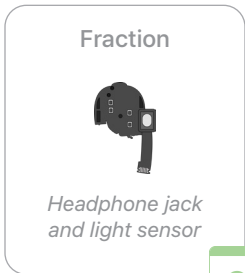
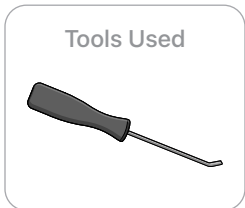
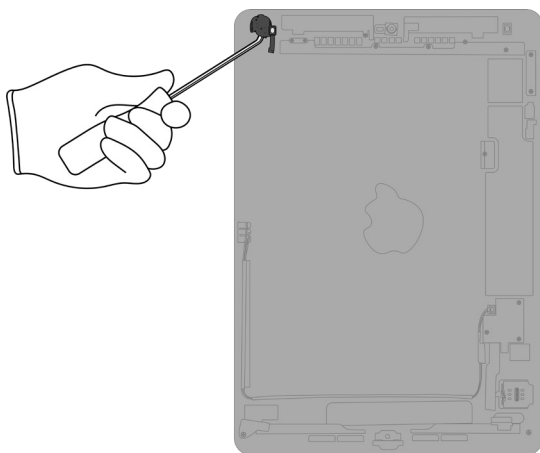

8. Pry off the left antenna.

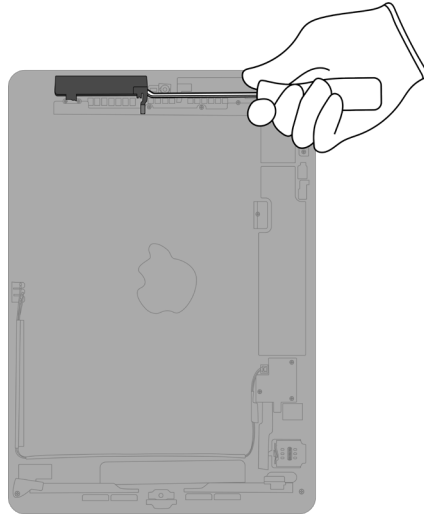

Tools Used



Fraction



Left antenna

Cu  
Copper

9. Pry off the front camera.

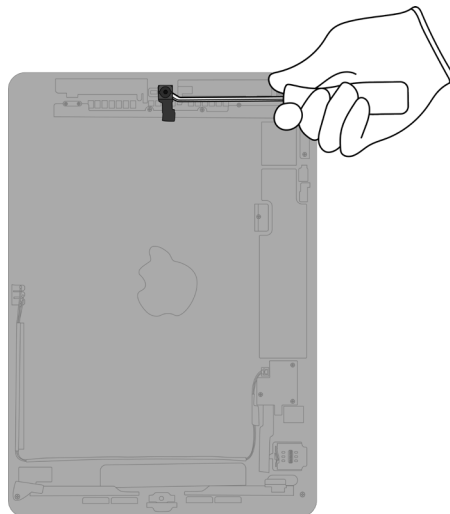

Tools Used



Fraction



Front camera

PMs  
Precious Metals

## 10. Pry off the right antenna.

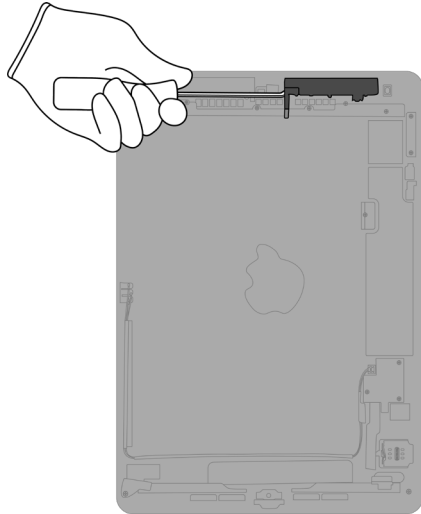

### Tools Used



### Fraction



*Right antenna*

**Cu**  
Copper

## 11. Pry off the light sensor.

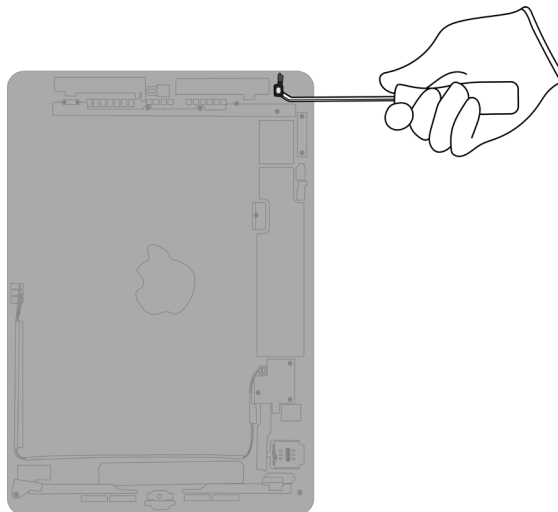

### Tools Used



### Fraction



*Light sensor*

**Cu**  
Copper

## 12. Pry off the rear camera.

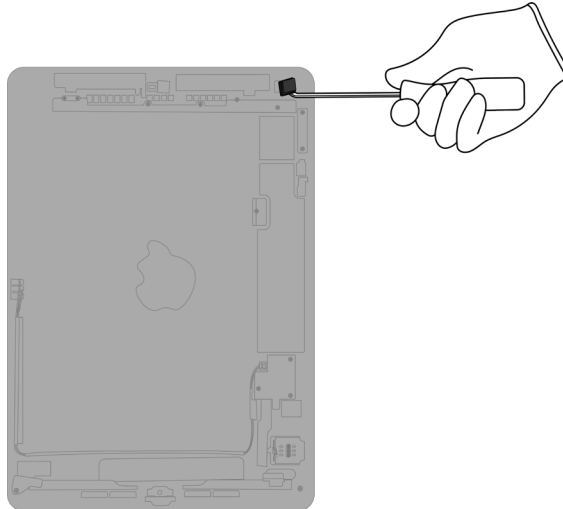

### Tools Used



### Fraction



Rear camera

PMs

Precious Metals

## 13. Pry off the main logic board.

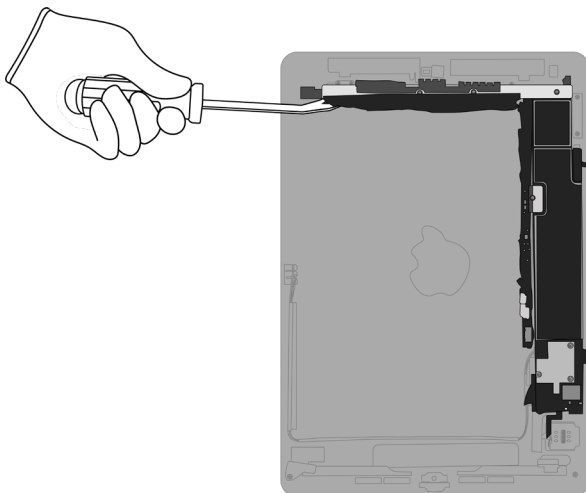

### Tools Used

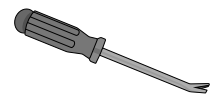

### Fraction



Main logic board

PMs

Precious Metals



**14.** Pry off the volume buttons cover.

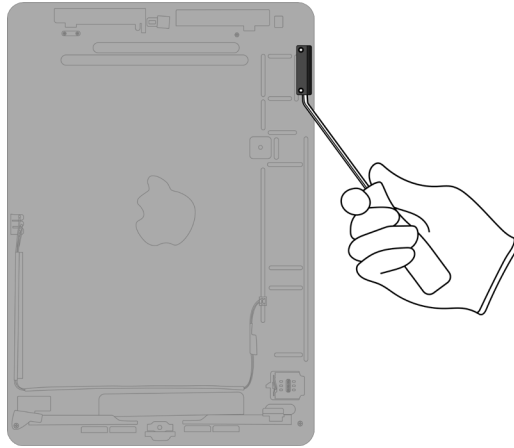

Tools Used



Fraction



Volume buttons cover

Fe

Ferrous

**15.** Pry off the volume buttons.

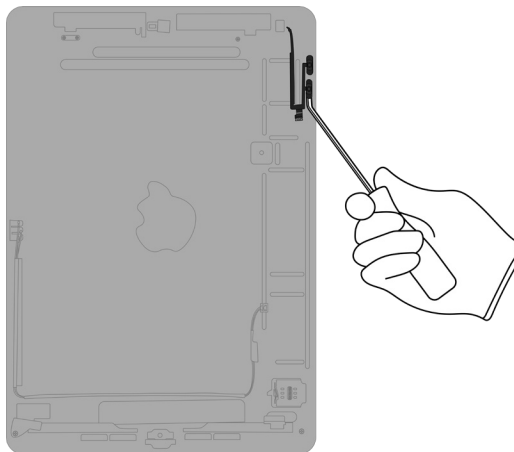

Tools Used



Fraction



Volume buttons

Cu

Copper

- 16.** (Cellular models only) Remove the SIM card and SIM tray by hand. Separate the SIM card from the SIM tray.

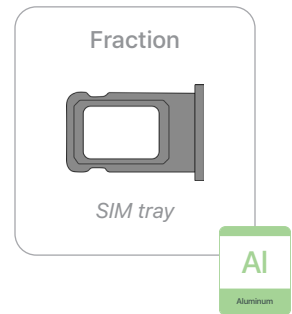
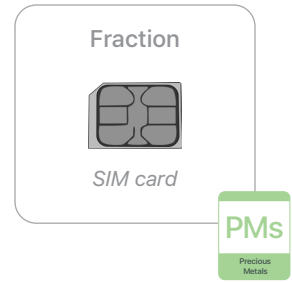
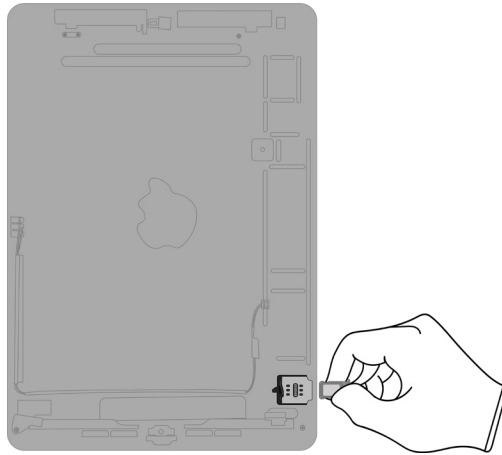

**17.** (Cellular models only) Pry off the SIM reader.

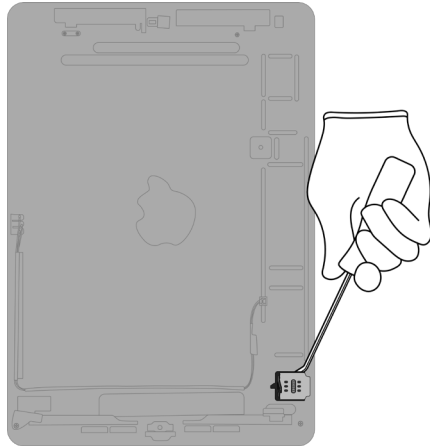

Tools Used



Fraction



*SIM reader*

**Cu**

Copper

**18.** Pry off the lower right speaker.

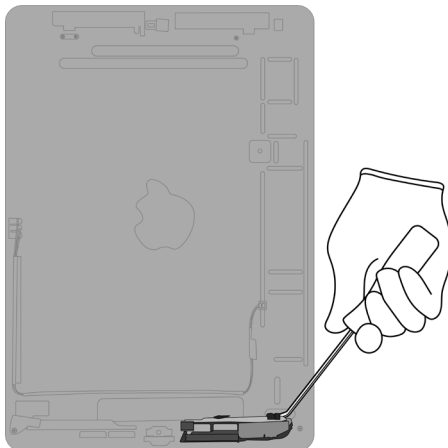

Tools Used



Fraction



*Lower right speaker*

**REE**

Rare Earth Elements

**19.** Pry off the Lightning connector assembly.

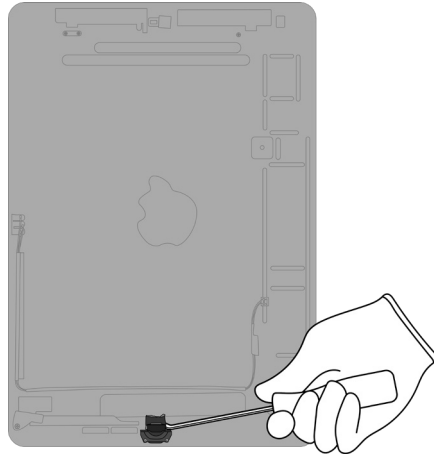

Tools Used



Fraction



*Lightning connector assembly*

**Cu**

Copper

**20.** Pry off the lower left speaker.

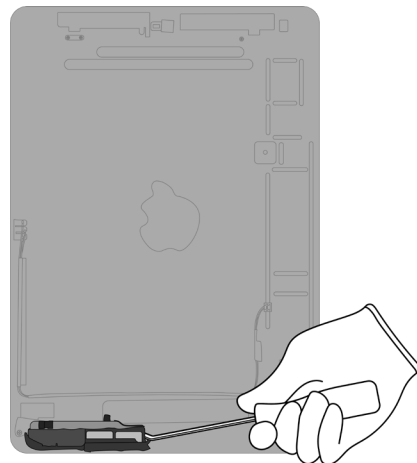

Tools Used



Fraction



*Lower left speaker*

**REE**

Rare Earth Elements

## 21. Pry off the Smart Connector.

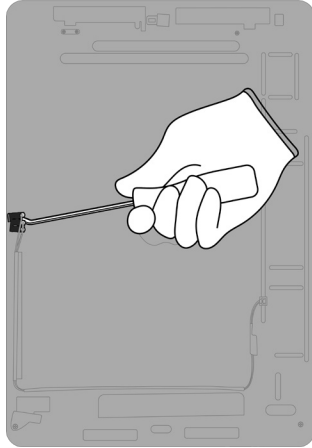

### Tools Used



### Fraction



Smart Connector

Cu  
Copper

## 22. Pry off the microphone.

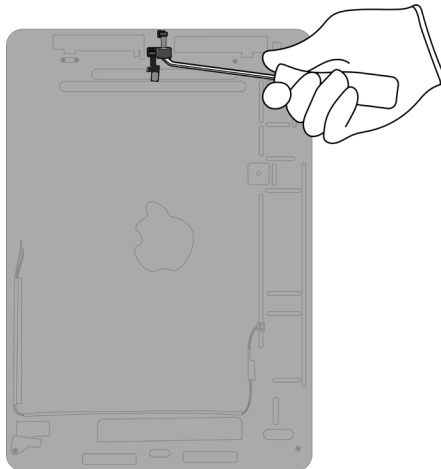

### Tools Used



### Fraction



Microphone

Cu  
Copper

## 23. Pry off the remaining ribbon cables.

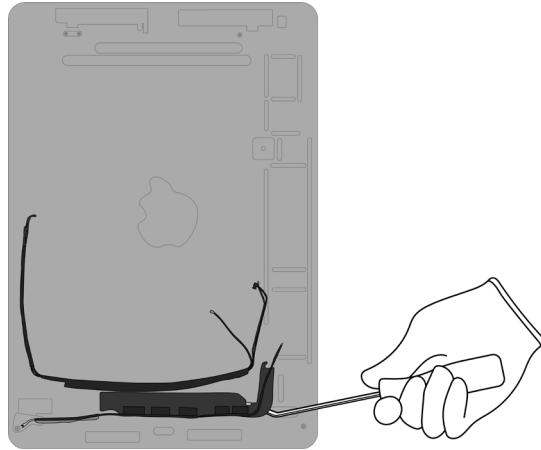

### Tools Used



### Fraction



Ribbon cables

Cu

Copper

## 24. Remove the magnets.

» *Bend both sides of the enclosure.*

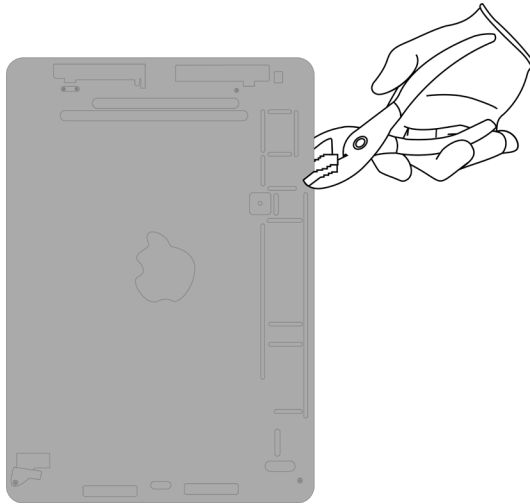

### Tools Used

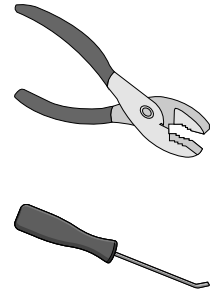

### Fraction



Magnets (x32)

REE  
Rare Earth  
Elements

» *Pry off the 32 magnets along both sides of the enclosure.*

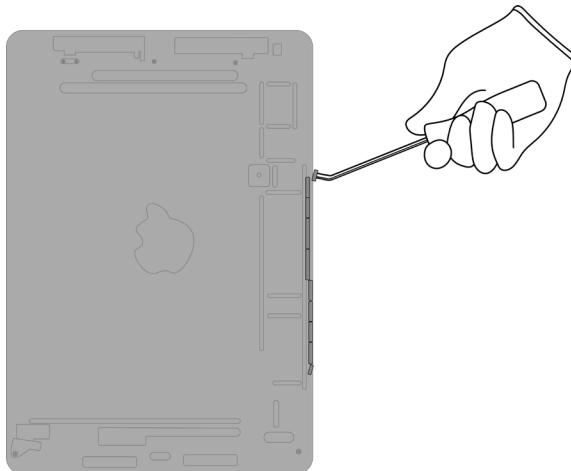

### Fraction

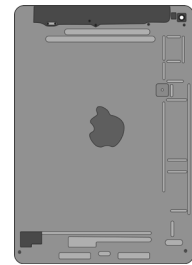





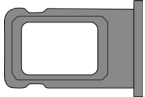

Enclosure

Al  
Aluminum

# Material Categorization of Output Fractions

All outputs from this process must be managed, handled, and disposed of in accordance with applicable waste laws and regulations, including but not limited to the Waste Framework Directive and its national enactments in Europe.

Fraction	Downstream Processing
<p data-bbox="435 554 570 579"><b>Aluminum</b></p>  <p data-bbox="461 737 542 762"><i>SIM tray</i></p>  <p data-bbox="451 1083 548 1108"><i>Enclosure</i></p>	<p data-bbox="964 554 1276 579"><b>Primary Target Material</b></p>  <p data-bbox="924 779 1317 804"><b>Potential Additional Materials</b></p>  

<p data-bbox="440 1207 565 1232"><b>Batteries</b></p>  <p data-bbox="337 1428 664 1453"><i>Lithium-ion polymer batteries (x2)</i></p>	<p data-bbox="964 1207 1276 1232"><b>Primary Target Material</b></p> 
--	--



**Fraction**

**Downstream Processing**

**Ferrous**



*Volume buttons cover*

**Primary Target Material**



**Glass**



*LCD cell*

**Primary Target Material**



**Potential Additional Materials**



## Fraction

## Downstream Processing

### Logic Boards



Display logic board



Front camera



Rear camera



Main logic board



SIM card

### Primary Target Material



### Potential Additional Materials



**Fraction**

**Downstream Processing**

**Mixed Electronics**

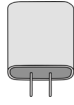

*Power adapter*

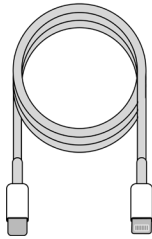

*Charge cable*



*Home button/Touch ID sensor*

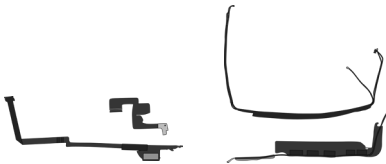

*Ribbon cables*



*Headphone jack and light sensor*



*Left antenna*



*Right antenna*

**Primary Target Material**



**Potential Additional Materials**



Mixed Electronics (cont.)



*Light sensor*



*Volume buttons*



*SIM reader*



*Lightning connector assembly*



*Smart Connector*



*Microphone*

**Fraction**

**Downstream Processing**

**Rare Earth Magnets**



*Lower right speaker*



*Lower left speaker*



*Magnets (x32)*

**Primary Target Material**



**Potential Additional Materials**

